



---

# SK magic Water Purifier

**WPU-2200C**

**WPU-2200D**



P.N : 57933-23100 (REV.00)



# Contents



## Cautions for Safe use

Please be sure to read this to use the product more safely.

- Cautions for Safe use \_\_\_\_\_ 3~6p
- Name of each part \_\_\_\_\_ 7p
- Internal structure \_\_\_\_\_ 8p
- Water purification system \_\_\_\_\_ 9p
- How to install \_\_\_\_\_ 10~11p
- How to use Magic Water Purifier \_\_\_\_\_ 12~14p
- Filter replacement \_\_\_\_\_ 15p
- How to respond to failures \_\_\_\_\_ 16p
- Product specification \_\_\_\_\_ 17p
- Processing instructions of discarded appliances \_\_\_\_\_ 18p

- Before using the product, make sure to read 'Cautions for Safe use' and use it correctly.
- After reading, please store it in place anyone can see and anywhere.
- This product is for the domestic (Korean) use. Do not use this product in any country having different electric currency and/or voltage.

※ Exterior may be changed to improve the quality of the product without notice.



## Cautions for Safe use

- Please be sure to keep the following instructions because of cautions related to power, installation and using to prevent damage from unexpected danger using the product safely and correctly.
- If cautions related to safety is used wrong, they are divided as follows according to expected danger and the degree of the damage, emergency of occurrence of danger.
- The appliance is not to be used by persons (including children) with reduced physical, sensory or mental capabilities, or lack of experience and knowledge, unless they have been given supervision or instruction.
- Children being supervised not to play with the appliance.



### Warning

When it may cause severe injury or death if the instructions are not followed



### Caution

When it may cause light injury or product damage if the instructions are not followed



This symbol is to get attention for the matters and operations that may cause danger.



This symbol marks the prohibitions.



This symbol marks the instructions that must be followed.

## Cautions for Safe use



### Warning



Make sure not to use any voltage other than AC 220-240V.

- It may cause electric shock or fire.



Do not install at a place where water may be in contact or with a lot of moisture such as water falling, rainwater dropping, bathroom, shower room, or outside building.

- It may cause electric shock, fire, or failure.

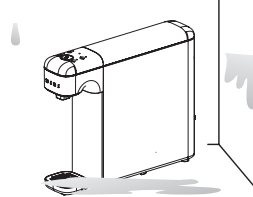

Do not install near heater.

- It may cause fire.

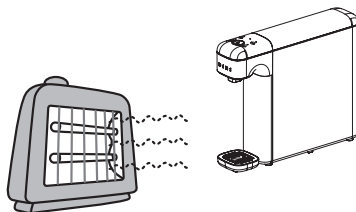

When replacing the filter, please replace this after unplugging the power cord.

- It may cause electric shock.

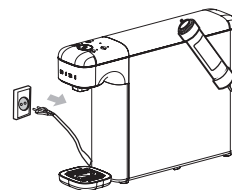

## Cautions for Safe use

 **Warning**

- !** **Cleanly wipe the dust or foreign object on the power plug before using the product.**
- It may cause electric shock or fire.



- ⊘** **When the power cord is damaged or shaking, do not use it.**
- It may cause electric shock, short circuit, or fire.
  - When the power cord is broken, please replace this with new one at customer center.

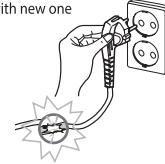

- ⊘** **Do not insert sharp steel wire and the driver in the machine.**
- It may cause failure of the product and electric shock.

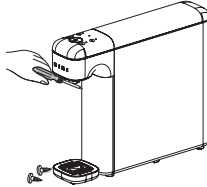

- ⊘** **Do not twist or bend the water supply hose.**
- It may cause water leakage, short circuit.

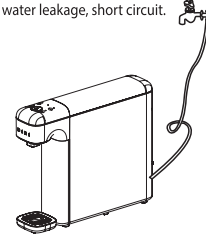

- ⊘** **Do not impose severe shock to the product.**
- It may cause product failure, damage, or electric shock.

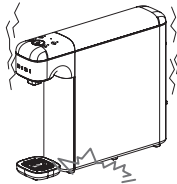

- !** **When you the plug power cord in or unplug, please plug in after drying water on your hands.**
- It may cause electric shock.

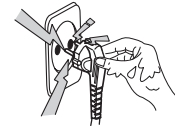

- ⊘** **Do not force to bend, tie, or pull the power cord.**
- It may cause fire because of electric shock or short circuit.



- !** **Use a socket with grounding connector of rated 10A or more exclusively.**
- Complicated wiring may cause fire because electric outlet is overheated.
  - If you use a socket without grounding connector, it may cause short circuit or electric shock.

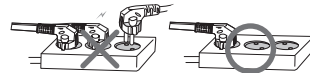

- !** **If there is a gas leakage, do not touch the power cord, and open the window for full ventilation.**
- If you handle the power cord, the flame may be generated and cause fire or burn.
- !** **Be careful not to put heavy object on the power cord or have the cord being pressed on the floor.**
- It may cause electric shock, short circuit, or fire.
- !** **Be careful not to put heavy object on the water supply hose or being stabbed by a sharp object.**
- It may cause electric shock or property damage by short circuit or water leakage.



### Cautions for Safe use

#### Warning

-  **Do not place a heavy object on the product.**
  - It may cause damage of the product.

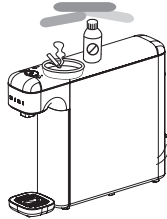

-  **Do not disassemble or repair the product without authorization.**
  - It may cause fire or electric shock.

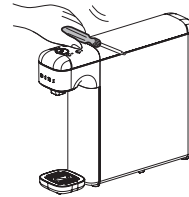

-  **Pull out the power cord in case of water supply cut off.**
  - It may cause product failure.

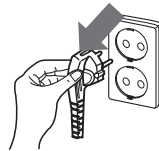

-  **Do not use thinner, benzene, or wax during the cleaning.**
  - It may cause product discoloration, or damage by peeling off, etc.

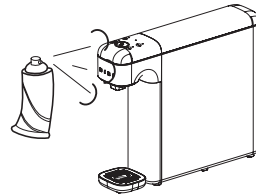

-  **Avoid fire equipment or direct sunlight.**
  - It may cause product exterior deformation.

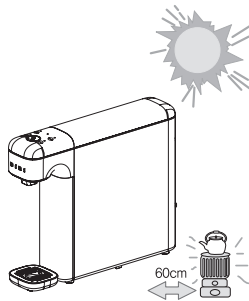

-  **Please install it at the hard and horizontal place.**
  - It may cause failure of the product.

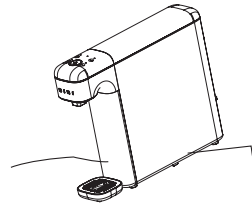

-  **During the installation, use SK magic genuine product for installation parts.**
  - It may cause water leakage or product damage. (water supply hoses, water supply valve, water purification filter, etc.)

-  **During the filter replacement, use authentic SK magic filters to replace filters.**
  - It may cause water quality or water taste problem.

-  **During the disposal of the waste appliance or water purification filter, dispose them according to the designated disposal procedure.**

- It may cause environmental contamination or injury.

-  **Do not place the water glass on the water drain.**
  - It may cause damage or injury and the water glass fall down.



**Cautions for Safe use**

**Caution**

- ❗ **Make sure to connect the product with cold water pipe.**
  - It may cause damage of the filter.

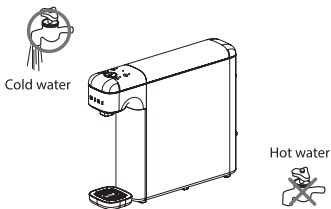

- ❗ **Install the product with 10cm gap or more from the wall.**
  - It may cause failure of the product.

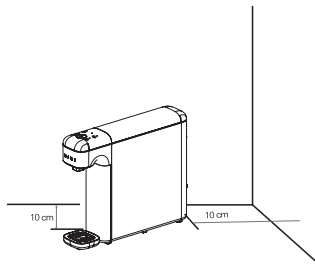

- ⊘ **During the product transportation, do not tilt more than 45 degrees.**
  - It may cause failure of the product.

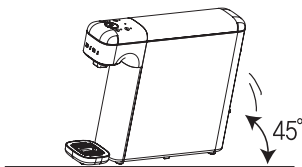

- ⊘ **During the operation of the product, do not move the product.**
  - It may cause failure of the product.

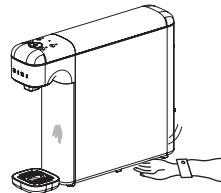

- ❗ **If water is flowing from the inside of the product or there is water around the product, please turn off water supply valve and contact the customer center (1800 18 7878).**

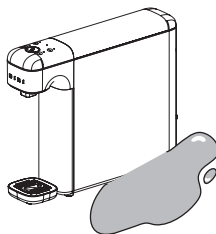

- ❗ **If you do not use the product for more than one day, lock the water supply valve.**
  - It may cause failure and property damage.
  - If you for a long period of time
    - Before 10 days: discharge the stored water 1~2 times before the usage.
    - After 10 days: If necessary, request checking to the customer center.

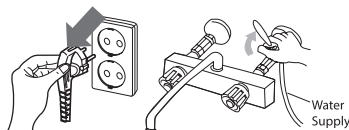



# Name of each part

Model WPU-2200

## Front

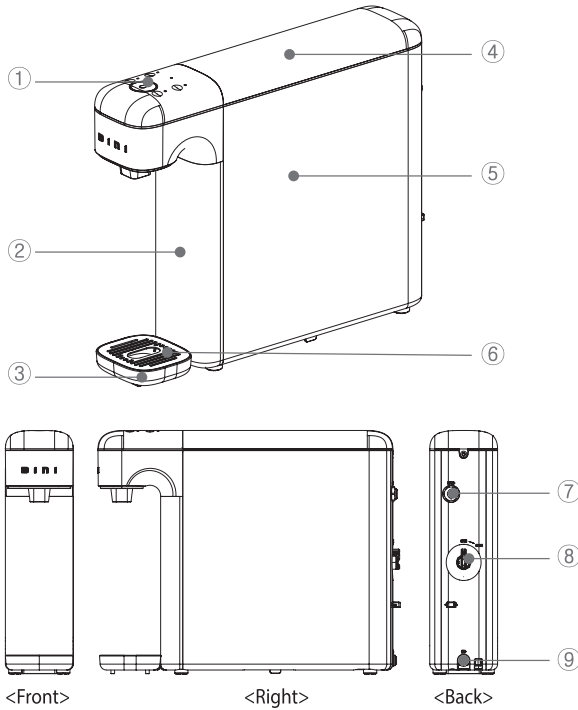

- ① Display / Control panel
- ② Front Case
- ③ Water Collector
- ④ Top Case
- ⑤ Side Case
- ⑥ Water Collector Cover
- ⑦ The supply slot of water faucet
- ⑧ Ball valve
- ⑨ The slot of water supply

## Accessories

User's Manual  
IoT Manual

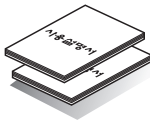

Management Card  
Manual Label



2 fittings



Stand  
support

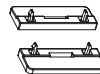

2 tubing hoses



# Internal structure

Model WPU-2200

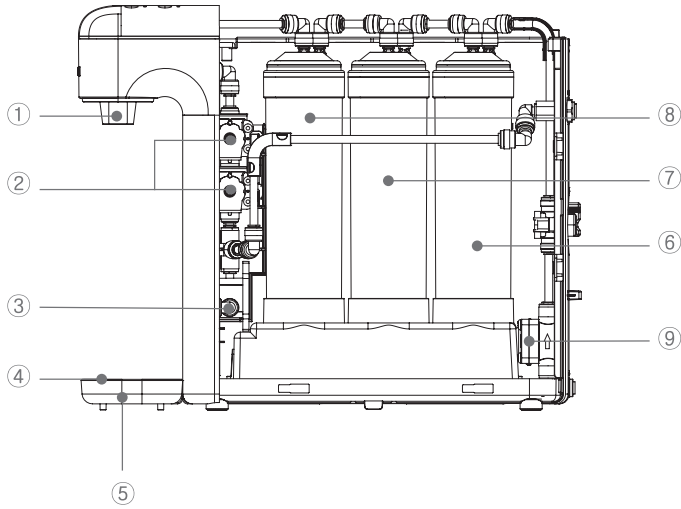

- |                    |                         |                               |
|--------------------|-------------------------|-------------------------------|
| ① Water intake tap | ④ Water Collector Cover | ⑦ Block carbon complex filter |
| ② Solenoid valve   | ⑤ Water Collector       | ⑧ Nano tech PAC filter        |
| ③ Flowmeter        | ⑥ Sediment filter       | ⑨ Reducing pressure valve     |





# Water purification system

Model WPU-2200

1. The following figure shows the composition of the Water purification system.



**Caution**

Do not open arbitrarily during use.

• It may cause property damage due to water leak, electric shock or short circuit.

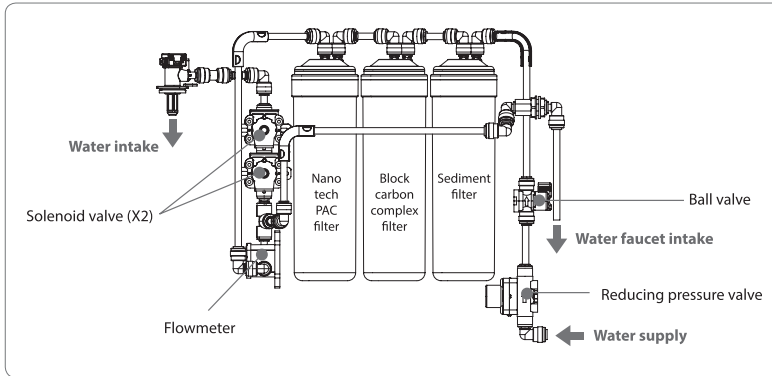

Step	Filter name	Material	Performance
Step 1	Sediment filter	Non-woven Fabric	Filtration
Step 2	Block carbon complex filter	Compressed Active Carbon + Non-woven Fabric	Filtration & Adsorption
Step 3	Nano tech PAC filter	Nano Aluminum Fiber Active Carbon Powder	Electrostatic Adsorption

2. Be sure to perform filter cleaning for each filter when installing the initial product and replacing the filter.

- Allow water to flow for about 15 minutes based on initial cleaning inside the filter. (Based on 20L water flow at water pressure of approximately 1kgf/cm<sup>2</sup>)
- Depending on the characteristics of the filter, bubbles or black water may come out only during initial cleaning, and there is nothing wrong with the purification performance.

※ White Coloring of Purified Water This is a temporary scene that may happen by the micro bubbles occurring during the water output in a direct purification product. The micro bubbles disappear naturally so that no change is made to the water quality.

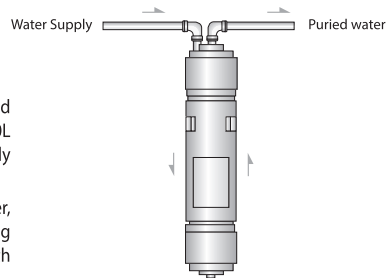

# How to install

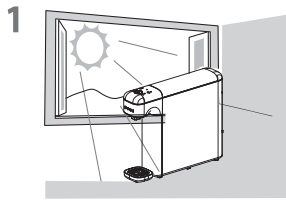

Please avoid heat of fire or direct sunlight.

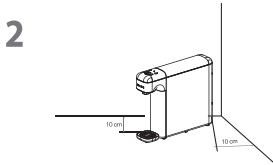

Please secure a safe space.

- Keep the distance from the wall more than 10cm considering the convenience of replacing the water supply hose and filter.

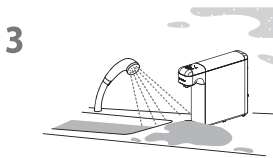

Please avoid sloping, humid, dusty, or direct splashing water.

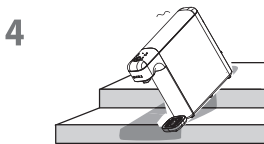

Please install on a hard and flat surface.

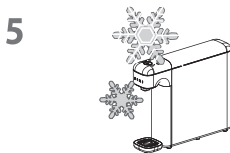

Please avoid installation where the temperature drops below 0°C.

- It may cause product malfunction due to filter and icing inside the product.

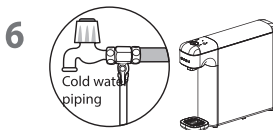

Please be sure to connect to cold water piping.

- When connecting to hot water piping, the water purifier filter may be damaged.

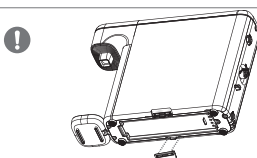

Please fix and install the stand support.

- Please assemble the two stand supports by inserting them into the hole at the bottom of the product as shown on the right.
- ▶ Stand support supports the product so that it does not fall

# How to install

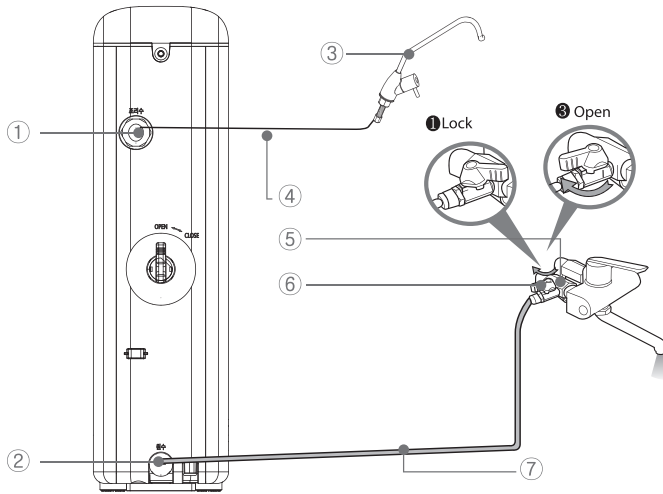

- |                                   |                                   |                      |
|-----------------------------------|-----------------------------------|----------------------|
| ① The supply slot of water faucet | ④ The supply hose of water faucet | ⑥ Water supply valve |
| ② The inlet of water supply       | ⑤ Cold water piping               | ⑦ Water supply hose  |
| ③ Water faucet valve              |                                   |                      |

## 1 Please install the water supply valve on the cold water piping side.

- ※ Caution
- Please install the water supply valve as it is locked.
  - Please be sure to install on the cold water piping. When installing on hot water piping, the filter and the product may be damaged.

## 2 Please plug the water supply hose into the inlet of water supply on the back of the product.

- ※ Caution
- Please connect to the correct position of the inlet of water supply. Please tighten by applying force to make a sound 'Cuk'. It may cause water leak.
  - The supply hose of water faucet is connected when installing the water faucet valve (sold separately).

## 3 Please turn water supply valve to open.

## 4 Please check hose connections for water leak after installation is complete.

- Water supply valve (hose)
- The inlet of water supply, The supply of hot water faucet
- Water faucet valve (The supply hose part of the faucet)
- Filter connection hose

Please be sure the water supply must use the tap water as water supply. Do not use underground water as water supply.

## How to use Magic Water Purifier

1

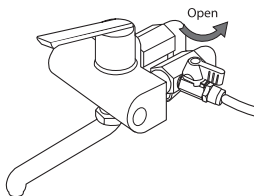

Open the water supply valve.

- The water purifier can be operated normally if water supply is supplied.

2

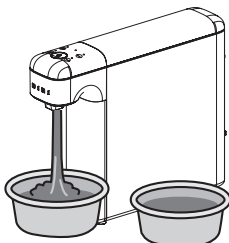

Please after the installation of the product, please drain water inside more than 2 times.

- Please after the first installation (including the previous installation), please drain water more than 2 times. (Please drain until clean water comes out).

3

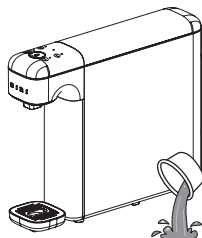

Please when not in use for a long time, discard the water inside completely and once more before use.

4

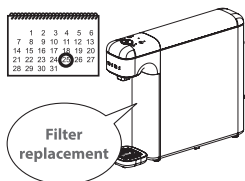

Please observe the periodic filter replacement cycle.

- In order to drink clean water, please manage the filter according to the filter replacement cycle.







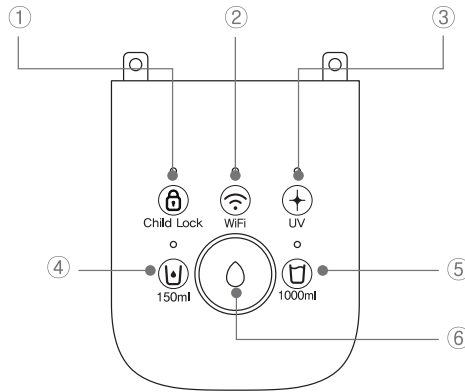

# How to use Magic Water Purifier

## Model WPU-2200C Display / Control panel



- |                                  |                              |
|----------------------------------|------------------------------|
| ① Child Lock select button / LED | ④ 150ml select button / LED  |
| ② WiFi select button / LED       | ⑤ 1000ml select button / LED |
| ③ UV selection button / LED      | ⑥ Water intake button / LED  |

## Operation Descriptions

 150m	<ul style="list-style-type: none"> <li>- Touch the water intake button during standard conditions</li> <li>- Stop when the water intake button is touched during operation</li> <li>- Operation status: LED is blinking when water intake status is displayed.</li> </ul>	 Child Lock	<ul style="list-style-type: none"> <li>- Press the lock button for 5 seconds (full button lock/unlock)</li> <li>- One cup and continuous LED off</li> <li>- When unlocking, press the lock button for 5 seconds</li> <li>- Power off automatically when power on</li> </ul>
 1000ml	<ul style="list-style-type: none"> <li>- Touch Continuous button, water intake button</li> <li>- Stop when the water intake button is touched during operation</li> <li>- Operation status: LED is blinking when water intake status is displayed.</li> <li>※ Return to the normal status after 7 seconds when not in use.</li> <li>- When 1000ml button is pressed for 5 seconds or more the buzzer sound is turned ON/OFF</li> </ul>	 WiFi	<ul style="list-style-type: none"> <li>- Enter pairing mode (5 seconds)(Use when connecting with the app on your phone)</li> <li>- WiFi initialization (WiFi + lock 5 seconds)</li> </ul>
	<ul style="list-style-type: none"> <li>- A fixed quantity when you press once.</li> <li>- Stop water intake when pressing once during water intake</li> </ul>	 UV	<ul style="list-style-type: none"> <li>- Use for manual sterilization</li> <li>- Press Cock sterilization button for 5 seconds. (Sterilization notification with water intake button LED ON / OFF</li> </ul>

※ Standard status one cup and water intake, cock sterilization selection button LED on.

※ Water intake may vary depending on water pressure and temperature.

Also, if you use water faucet when one cup or continuous water intake, you will not be able to take a quantitative water intake.

※ Cleaning the UV LED sight glass: Experts visit and clean for efficient sterilization performance. It may cause damage of the product and water leak when the consumer directly removes.





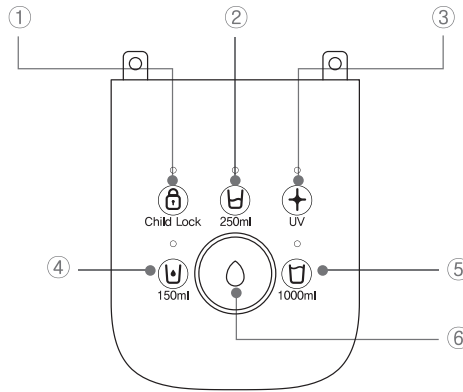

# How to use Magic Water Purifier

## Model WPU-2200D Display / Control panel



- |                                  |                              |
|----------------------------------|------------------------------|
| ① Child Lock select button / LED | ④ 150ml select button / LED  |
| ② 250ml select button / LED      | ⑤ 1000ml select button / LED |
| ③ UV selection button / LED      | ⑥ Water intake button / LED  |

### Operation Descriptions

 150ml	<ul style="list-style-type: none"> <li>- Touch the water intake button during standard conditions</li> <li>- Stop when the water intake button is touched during operation</li> <li>- Operation status: LED is blinking when water intake status is displayed.</li> </ul>	 Child Lock	<ul style="list-style-type: none"> <li>- Press the lock button for 5 seconds (full button lock/unlock)</li> <li>- One cup and continuous LED off</li> <li>- When unlocking, press the lock button for 5 seconds</li> <li>- Power off automatically when power on</li> </ul>
 1000ml	<ul style="list-style-type: none"> <li>- Touch Continuous button, water intake button</li> <li>- Stop when the water intake button is touched during operation</li> <li>- Operation status: LED is blinking when water intake status is displayed.</li> <li>※ Return to the normal status after 7 seconds when not in use.</li> </ul>	 250ml	<ul style="list-style-type: none"> <li>- Touch the water intake button during standard conditions</li> <li>- Stop when the water intake button is touched during operation</li> <li>- Operation status: LED is blinking when water intake status is displayed.</li> </ul>
	<ul style="list-style-type: none"> <li>- A fixed quantity when you press once.</li> <li>- Stop water intake when pressing once during water intake</li> </ul>	 UV	<ul style="list-style-type: none"> <li>- Use for manual sterilization</li> <li>- Press Cock sterilization button for 5 seconds. (Sterilization notification with water intake button LED ON / OFF)</li> </ul>

※ Standard status one cup and water intake, cock sterilization selection button LED on.

※ Water intake may vary depending on water pressure and temperature.

Also, if you use water faucet when one cup or continuous water intake, you will not be able to take a quantitative water intake.

※ Cleaning the UV LED sight glass: Experts visit and clean for efficient sterilization performance. It may cause damage of the product and water leak when the consumer directly removes.



# Filter replacement

## Filter replacement

- 1** Lock water supply valve and ball valve.

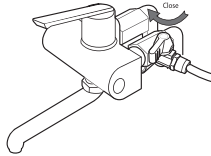

- 2** Drain the water completely inside the water purifier.

Please use one cup or continuous water intake method.



- 3** Please unplug the power cord of the water purifier.

Caution: Touching the power cord with wet hands may cause an electric shock.

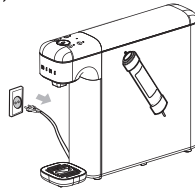

- 4** Please remove the top case.

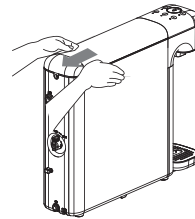

- 5** Remove the filter to be replaced and replace it with a new filter.

After replacing the filter, connect the hose correctly and check that there is no water leak.

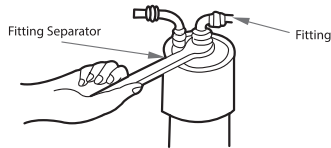

- 6** Please close the top case.

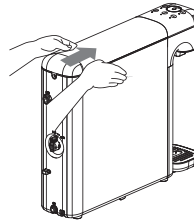

- 7** Open the water supply valve to supply water again.

Please drain water twice after replacing the filter.

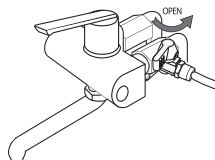

- To purchase or replace filters, please contact the customer service center.  
(Customer service center: 1800 18 7878)

- The filter replacement notification will be provided by a phone call 2~3 days before filter replacement cycle through our computer management system.

※ Filter replacement Cycle: Filter replacement Cycle refers the time when the filter is expected to be unable to perform. In case of low quality water supplies or high use frequencies, the cycle may become shorter.



## How to respond to failures

- Before you request repair of disorder, Please check below but if you still have problems, contact customer service center.

Condition	Possible cause	Measures
When water comes out too slowly	End of filter life	• Replace the filter
	Too low water temperature	• The lower the water temperature, the less water is being purified.
	Using water faucet	• Please lock water faucet valve.
Water leak occurs from the product.	Bad assembly (connection) area	• Please after locking the water supply valve, stop operating and contact customer service center.
Unpleasant taste and smell happens	End of Post (granular carbon) complex filter life	• Replace the post (granular carbon) complex filter, drain it, and then discard about 20 liters of purified water and use it.
	Long-term storage under inappropriate conditions	• Replace all filters and clean them.





# Product specification

## Model WPU-2200

- Appearance and specifications may be changed or improve the products capacity.
- Filter replacement cycle depends on water usage.

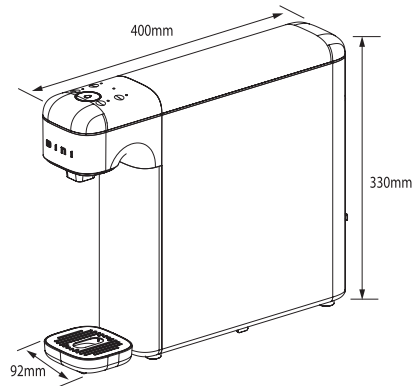

Product name	WPU-2200C / WPU-2200D		
Rated Voltage	AC220-240V 50/60Hz		
Power consumption	Purified water 12W		
How to come out water	Electronic coming out water system		
Filter classification	Sediment filter	Block carbon complex filter	Nano tech PAC filter
Filter material	Non-woven Fabric	Compressed activated carbon + Non-woven	Nano Aluminum Fiber Active Carbon Powder
Product Size	92(L) X 400(D) X 330(T)mm		
Product Weight	3kg		
Usage water supply pressure	98 ~ 780kPa		
Usage environment temperature	5°C~43°C		



# Processing instructions of discarded appliances

## Processing instructions of discarded appliances

Dispose waste home appliances as followings for the environmental protection.

### 1 In case of Free Disposal

- In case of disposing an old SK magic product after purchasing a new SK magic product, SK magic will handle the old one for free when we deliver the new product (Exclusive service for SK magic product.)

### 2 In case of Paid Disposal

- In case of disposing a product that has been used without purchasing a SK magic product, please contact the resident office of your area for the disposal.
- SK magic provides the paid product disassembly service for customer's convenience. (Customer Center: 1800 18 7878)

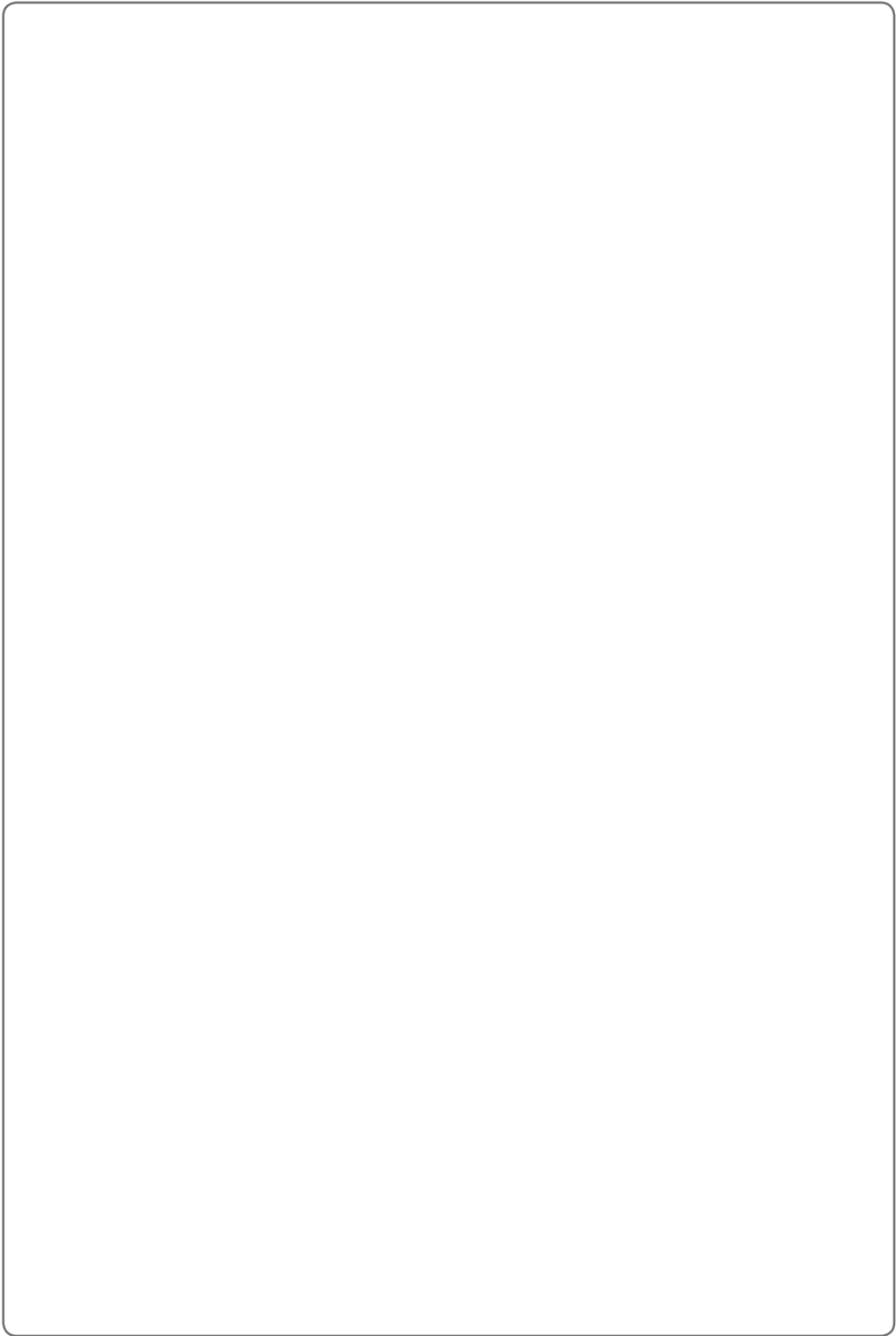



## **SK magic Customer Center | 1800 18 7878 [www.skmagic.com.my](http://www.skmagic.com.my)**

Customer Center provide the e-commerce and telephone order sales service for consumables and accessories including dishwasher detergents & conditioners / air cleaner filters / water purifier filters / bidet filters / water softener recycling solution / batteries, burner caps and heads, and tripods for gas cooking stoves and gas oven stoves / oven wares, steam wares, oven gloves, oven grills, and water containers for electric ovens as a part of the customer service.

